



● Character

It is a pneumatic valve controlled by micro electric signal, with small dimension, large flow, handsome shape, reliable performance and long service life. It can be installed in the integration. It is an ideal directional control element, applicable to the electromechanical integration. There are multiple Specifications cations for your choice.

● Ordering Code

TG	25	1	1	—	06	C	AC220V
Series	Function	Connection Code	Control Form		Pipe size	Working mode	Standard voltage
	23 : 2 positions/3 Ports 25 : 2 positions/5 Ports 35 : 3 positions/5 Ports	1 : 1/8 2 : 1/4 3 : 3/8 4 : 1/2	1 : Single solenoid operated 2 : Double solenoid operated		06 : G1/8 08 : G1/4 10 : G3/8 15 : G1/2	No mark : 2 positions C : Close center E : Release center P : Pressed Center	DC24V AC110V AC220V

■ Solenoid specifications

Allowable Voltage Range	±10%	
Insulated Grade	Class B or Equivalent	
Response Time	0.05 Sec	
Power Consumption	AC	Start : 5.6VA, Keep on : 5.4VA
	DC	4W
Surge Voltage Suppressor	AC: Varistor, DC: Diode	
Indicator Light	Neon Light, LED	

● Maintenance Notice:

1. Be sure to check up the valve before installation.
2. Before installation, please confirm the voltage connection and airflow direction are right.
3. Notice to do dustproof. It's best to install a silencer or speed control silencer in the port of solenoid valve.
4. Metallic particle, dust and oil stain in pipes and fittings must be Eliminated before connected.

■ Technical Parameter

Specification	Item	Function	Pipe Size	Nominal Diameter (mm)	Applicable Medium	Applicable Pressure Range	Operating Method	Max Action Frequency	Lubrication	Medium Temperature
TG2311-06	2 Positions/ 3Ports		G1/8	4	Air	0.15 ~ 0.8 MPa	Internally Piloted	5 Cycles/Sec	Needless	-5 ~ 60°C
TG2321-08			G1/4	4.5						
TG2331-10			G3/8	6.5						
TG2341-15			G1/2	8						
TG2511-06 TG2512-06	2 Positions/ 5Ports		G1/8	4						
TG2521-08 TG2522-08			G1/4	4.5						
TG2531-10 TG2532-10			G3/8	6.5						
TG2541-15 TG2542-15			G1/2	8						
TG3512-06C.E.P	3 Positions/ 5Ports		G1/8	3.5	Air	0.2 ~ 0.8 MPa	Internally Piloted	3 Cycles/Sec	Needless	-5 ~ 60°C
TG3522-08C.E.P			G1/4	4						
TG3532-10C.E.P			G3/8	5						
TG3542-15C.E.P			G1/2	6.5						

TG Series Solenoid Valve

2 Positions/5 Ports Solenoid Valve



● TG2511-06 ● TG2512-06

● TG2511-06

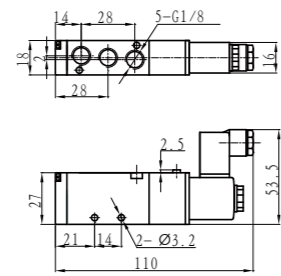

● TG2512-06

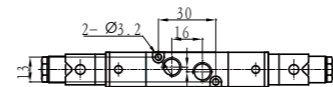
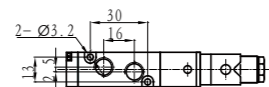
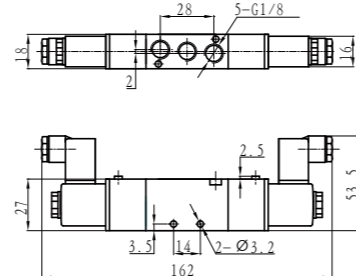

2 Positions/5 Ports Solenoid Valve



● TG2521-08
TG2521-06

● TG2522-08
TG2522-06

● TG2521-08

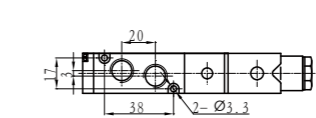
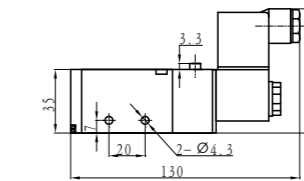
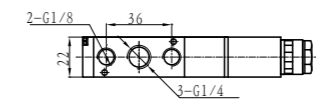

TG Series Solenoid Valve

● TG2522-08

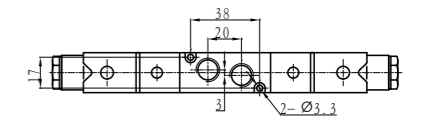
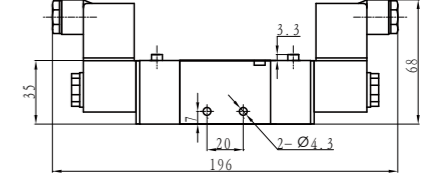
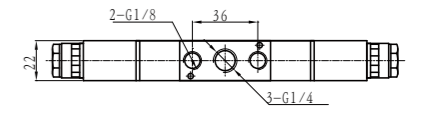

2 Positions/3 Ports Solenoid Valve



● TG2311-06 ● TG2321-08

● TG2311-06

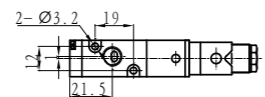
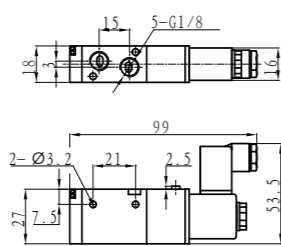

● TG2321-08

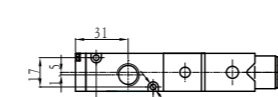
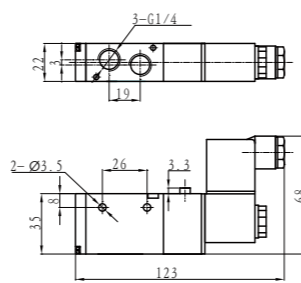

● TG2531-10
TG2531-08

● TG2532-10
TG2532-08

● TG2531-10

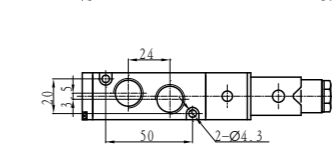
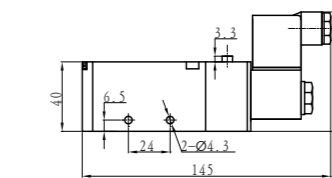
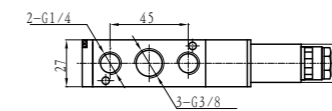

● TG2532-10

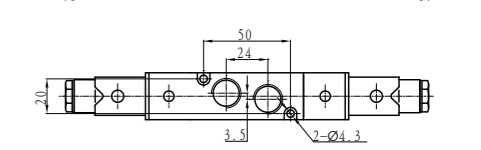
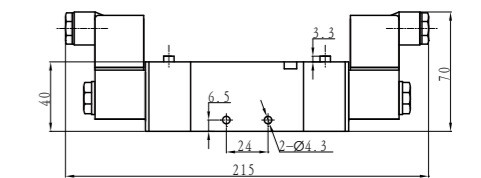
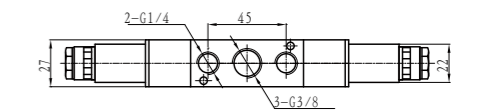

2 Positions/3 Ports Solenoid Valve



● TG2331-10 ● TG2341-15

● TG2331-10

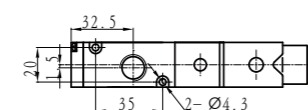
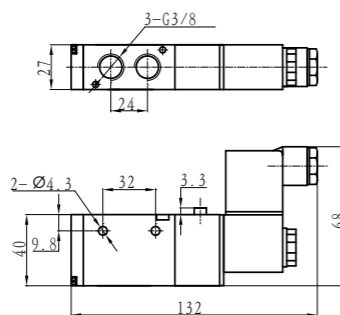

● TG2341-15

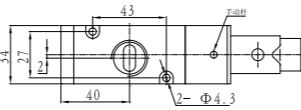
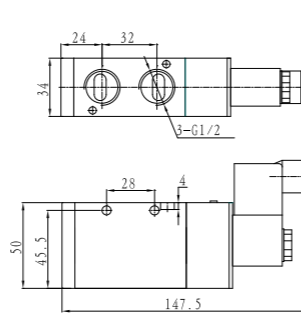

● TG2541-15 ● TG2542-15

● TG2541-15

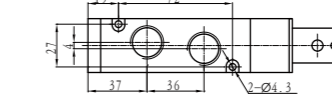
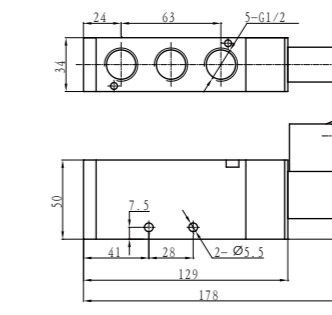

● TG2542-15

