

BD

ISO 15407-1/2 (VDMA 24563) ISO 02 (18 mm) - ISO 01 (26 mm) Valves

BDE = solenoid valves ISO 15407/2 with integrated electric connection including 24 V DC coils and connector

BDB = solenoid valves ISO 15407/1 with external electric connection with M12 connector including 24 V DC coils and connector

BDA = valves and solenoid valves ISO 15407/1 (without coils and connectors to be ordered separately)

- TC - TX Serial communication system available for BDE series
- Modular sub-base ISO-VDMA
- Sub-base with increased capacity

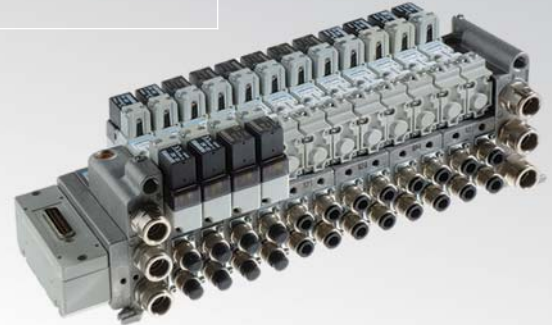

TECHNICAL CHARACTERISTICS

Ambient temperature	-20 ÷ +50 °C
Fluid temperature	max +50 °C
Fluid	50 µm filtered and not dehumidified air, lubricated or not
Commutation system	spool
Ways/Positions	3/2+3/2, 5/2, 5/3
Pressure	electric control = 9 bar max pneumatic control = 10 bar max
Control	indirect electro - pneumatic, pneumatic
Return	mechanical spring, pneumomechanical spring
Nominal Ø (mm)	18 mm = 6, 26 mm = 8

Nominal flow rate (NI/min) for valves and solenoid valves side 18 mm

Sub-base in die-cast aluminium according to standard

Fittings:	VDMA-ISO			Oversize		
	Ø4	Ø6	Ø8	Ø4	Ø6	Ø8
5/2	200	440	620	200	480	800
5/3	200	440	580	200	460	720
3/2+3/2	200	440	600	200	460	720

Nominal flow rate (NI/min) for valves and solenoid valves side 26 (b)

Sub-base in die-cast aluminium according to standard

Fittings:	VDMA-ISO				Oversize			
	Ø6	Ø8	Ø10	Ø12 ^(c)	Ø6	Ø8	Ø10	Ø12 ^(c)
5/2	500	950	1200	1250	500	1050	1500	1700
5/3	500	900	1100	1150	500	1050	1300	1400
3/2+3/2	500	950	1150	1250	500	1050	1450	1650

(a) = manifold sub-base 2 valve places and end plates with side connections in aluminium and fixing plate for fittings standard supplied with sub-base.

(b) = manifold sub-base 1 valve place and end plates with side connections in aluminium and fixing plate for fittings standard supplied with sub-base.

(c) = the external Ø of the G 3/8 fitting for tube Ø12 mm must not exceed 20 mm

CONSTRUCTIVE CHARACTERISTICS

Body valve	acetalic resin
Cover	zamak
Seals	nitrile rubber
Sub-base	die-cast aluminium
Actuators	technopolymer
Spool	aluminium

ELECTRIC CHARACTERISTICS

Electropilot	DD series (U05)
Voltage	24 V DC (± 10%), 12 V DC upon request
Power consumption	2 W
Protection degree	IP65
Manual override	with button with tool 1 position

Flow rate characteristics

>> Valves and solenoid valves side 18 mm

5/2 Oversize sub-base for Ø8 mm tube

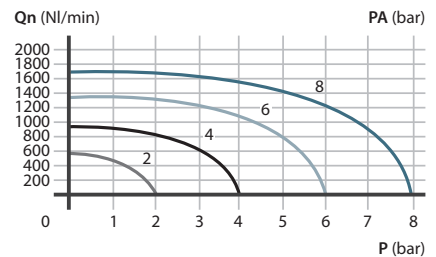

>> Valves and solenoid valves side 26 mm

5/2 Increased sub-base for Ø12 mm tube

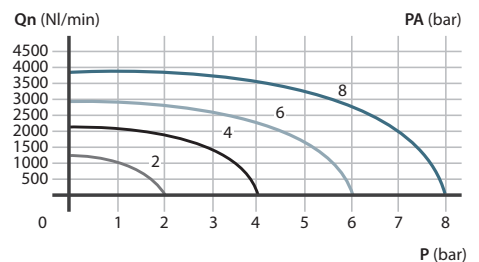

P = Working pressure
PA = Supply pressure
Qn = Nominal flow rate

2
Standardized valves

ISO 15407 specifications

They establish the dimensions of the bearing surface and the minimum distance between two valve places, guaranteeing the interchangeability and possibility to include any valve providing it complies with above specifications.

>> Dimensioning of the bearing surface according to ISO 15407-1/2 specification with integrated electric connector

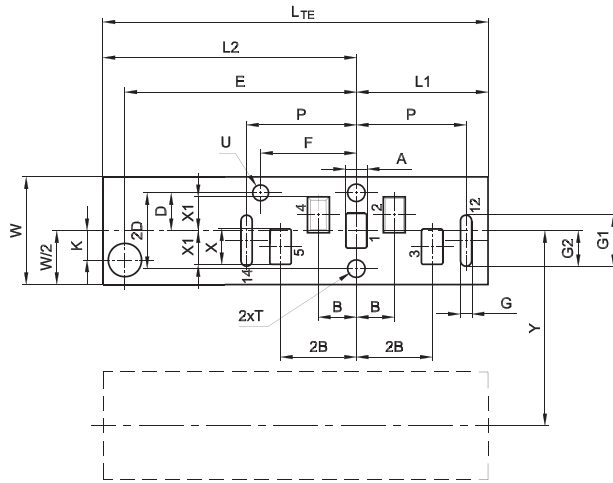

Y = Min. distance between two interface axes of the same dimension mounting on the same manifolds

U = Position bore, depth V

	A	B	D	E	F	G	G1	G2	K	L1	L2	L _{TE}	P	T	U	V	W	X	X1	Y
										min.	min.	min.					min.			
18 mm	3,5	7	6,25	50	17	2	8	6	3,35	25	55,5	80,5	20	M3	3,2	4	18	6,5	5,25	19
26 mm	5,5	9,5	9,5	58	24	3	13	9	7,35	33	63,5	96,5	27,5	M4	3,2	4	26	9	8,5	27

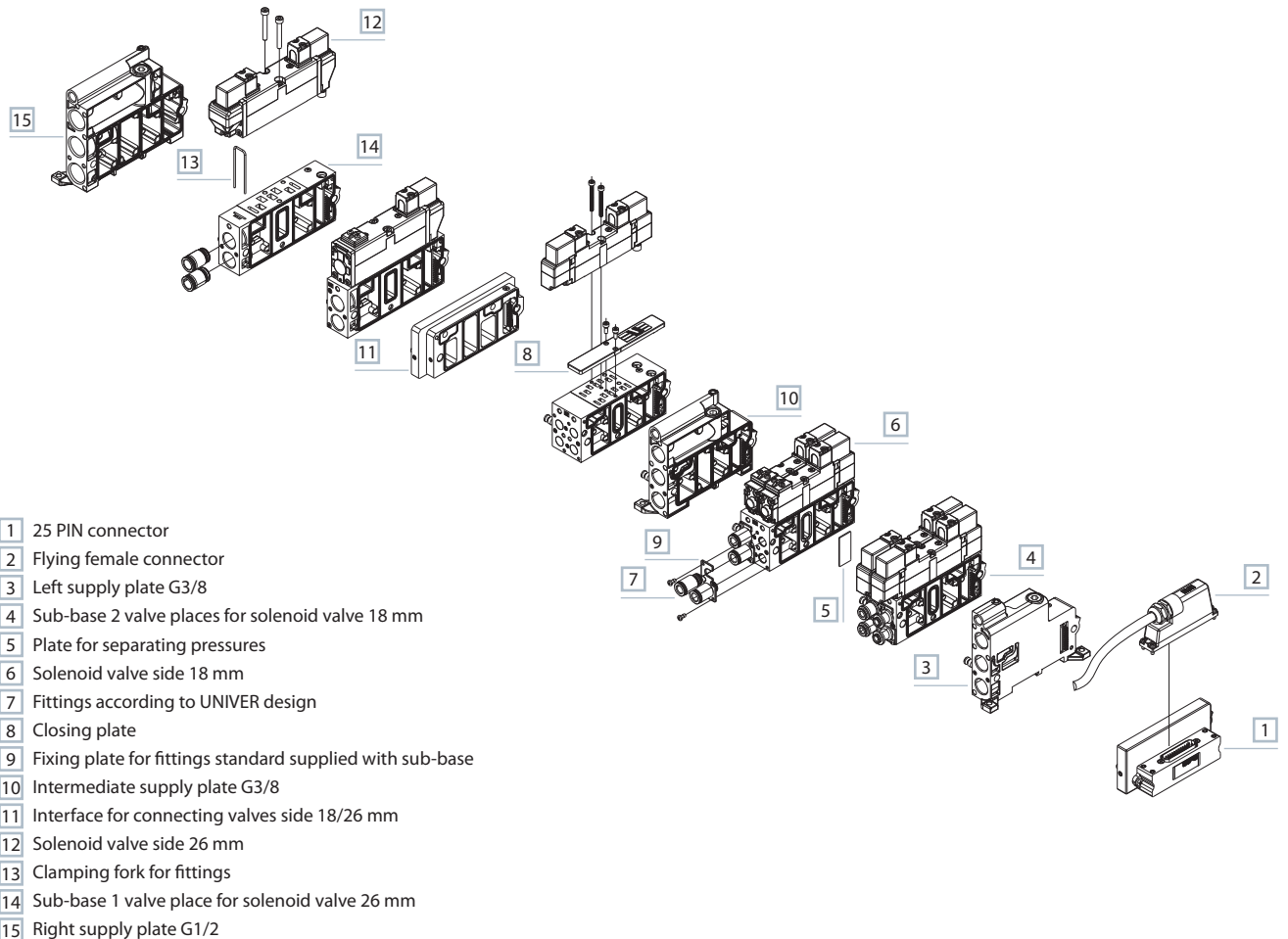

- 1 25 PIN connector
- 2 Flying female connector
- 3 Left supply plate G3/8
- 4 Sub-base 2 valve places for solenoid valve 18 mm
- 5 Plate for separating pressures
- 6 Solenoid valve side 18 mm
- 7 Fittings according to UNIVER design
- 8 Closing plate
- 9 Fixing plate for fittings standard supplied with sub-base
- 10 Intermediate supply plate G3/8
- 11 Interface for connecting valves side 18/26 mm
- 12 Solenoid valve side 26 mm
- 13 Clamping fork for fittings
- 14 Sub-base 1 valve place for solenoid valve 26 mm
- 15 Right supply plate G1/2

Codification key

B	D	_	3	3	4	4	2	4	D
1	2	3	4	5	6	7			

1 Series	2 Size	3 Type
BDE = solenoid valves with integrated electric connection 24 V DC (including coil and connector)	3 = side 18 mm 4 = side 26 mm	2 = 5/2 3 = 5/3 c.c. 4 = 5/3 o.c. 5 = 5/3 p.c.
BDB = solenoid valves with integrated electric connection 24 V DC, with M12 connector (including coil and connector)		6 = 3/2+3/2 NC-NC 7 = 3/2+3/2 NC-NO 8 = 3/2+3/2 NO-NO

4 Control 14	5 Return 12	6 Coil voltage
4 = electric amplified	0 = pneumomechanical spring 1 = mechanical spring 4 = electric amplified 7 = electric not amplified	24 = 24 V DC (standard) 12 = 12 V DC (upon request)

7 Options
D = externally servoassisted electropilot

B	D	A	3	3	4	4	D
1	2	3	4	5	6		

1 Series	2 Size	3 Type
BDA = valves and solenoid valves (without coil and connectors to be ordered separately)	3 = side 18 mm 4 = side 26 mm	2 = 5/2 3 = 5/3 c.c. 4 = 5/3 o.c. 5 = 5/3 p.c. 6 = 3/2+3/2 NC-NC 7 = 3/2+3/2 NC-NO 8 = 3/2+3/2 NO-NO

4 Control 14	5 Return 12	6 Options
3 = pneumatic amplified 4 = electric amplified only DC 5 = electric amplified DC and AC	0 = pneumomechanical spring 1 = mechanical spring 2 = pneumatic not amplified 3 = pneumatic amplified 4 = electric amplified only direct current 5 = electric amplified direct and alternating current 7 = electric non amplified only direct current 8 = electric non amplified direct and alternating current	D = externally servoassisted electropilot

>> Coils U05 side 15 mm

Part no.	Nominal voltage		Frequency HZ	Power consumption			
	DC v	AC v		CCW		CA	VA
			rating	start	rating	start	
DD-040	-	24	50/60	-	-	2,3	3,2
DD-042	12	-	-	2,5	2,5	-	-
DD-050	-	48	50/60	-	-	2,3	3,2
DD-051	24	-	-	2	2	-	-
DD-052	24	-	-	2,5	2,5	-	-
DD-060	-	110	50/60	-	-	3,5	3,2
DD-070	-	230	50/60	-	-	2,3	3,2

LED connector AM-5109/AM5105 24V DC 50/60 Hz
It can rotate by 180° on the coil - IP65 - cable connection PG9

o.c. = open centres c.c. = closed centres p.c. = pressurized centre

Single electric impulse 18 mm



Weight (Kg): 0,112

	Symbol	Control	Return	Pressure		Time (ms)		Part no.
				bar		En.	De-en.	
5/2		electric amplified	pneumo mechanical spring	1,8÷9		15	25	BDE-324024
5/2		electric amplified	mechanical spring	2,5÷9		14	37	BDE-324124

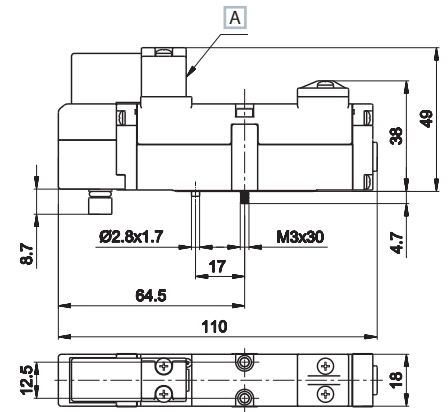

A Manual override

Double electric impulse 18 mm



Weight (Kg): 0,131

	Symbol	Control	Return	Pressure		Time (ms)		Part no.
				bar		En.	De-en.	
5/2		electric amplified	electric amplified	0,8÷9		16	16	BDE-324424
5/3 c.c.		electric amplified	electric amplified	2,1÷9		14	31	BDE-334424
5/3 o.c.		electric amplified	electric amplified	2,1÷9		14	31	BDE-344424
5/3 p.c.		electric amplified	electric amplified	2,1÷9		31	14	BDE-354424
3/2 NC + 3/2 NC		electric amplified	electric amplified	1,8÷9		17	22	BDE-364424
3/2 NC + 3/2 NO		electric amplified	electric amplified	1,8÷9		17	22	BDE-374424
3/2 NO + 3/2 NO		electric amplified	electric amplified	1,8÷9		17	22	BDE-384424

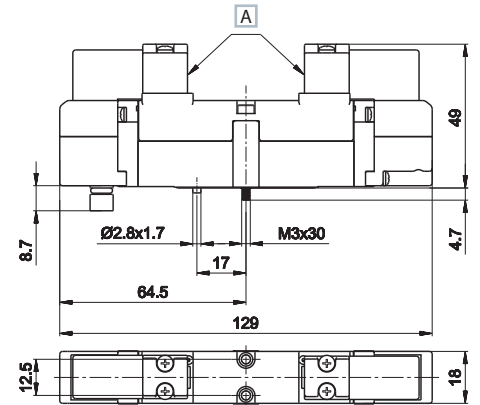

A Manual override

o.c. = open centres c.c. = closed centres p.c. = pressurized centres

Single electric impulse 26 mm



Weight (Kg): 0,205

	Symbol	Control	Return	Pressure bar	Time (ms)		Part no.
					En	De-en.	
5/2		electric amplified	pneumo mechanical spring	1,8÷9	21	40	BDE-424024
5/2		electric amplified	mechanical spring	2,5÷9	20	50	BDE-424124

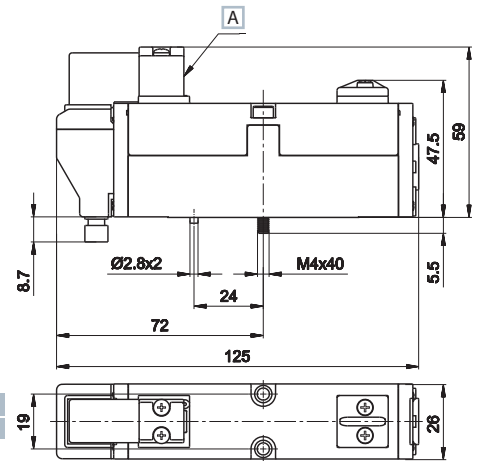

A Manual override

Double electric impulse 26 mm



Weight (Kg): 0,232

	Symbol	Control	Return	Pressure bar	Time (ms)		Part no.
					En.	De-en.	
5/2		electric amplified	electric amplified	0,8÷9	17	17	BDE-424424
5/3 c.c.		electric amplified	electric amplified	2,1÷9	16	54	BDE-434424
5/3 o.c.		electric amplified	electric amplified	2,1÷9	16	54	BDE-444424
5/3 p.c.		electric amplified	electric amplified	2,1÷9	63	16	BDE-454424
3/2 NC + 3/2 NC		electric amplified	electric amplified	1,8÷9	20	27	BDE-464424
3/2 NC + 3/2 NO		electric amplified	electric amplified	1,8÷9	20	27	BDE-474424
3/2 NO + 3/2 NO		electric amplified	electric amplified	1,8÷9	20	27	BDE-484424

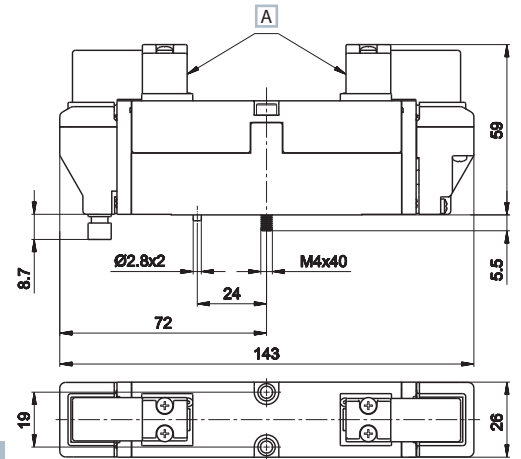

A Manual override

o.c. = open centres c.c. = closed centres p.c. = pressurized centres

Single electric impulse 18 mm

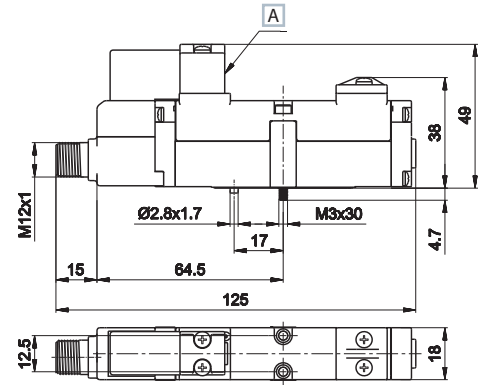

Weight (Kg): 0,117

	Symbol	Control	Return	Pressure bar	Time (ms)		Part no.
					En.	De-en.	
5/2		electric amplified	pneumo mechanical spring	1,8÷9	15	25	BDB-324024
5/2		electric amplified	mechanical spring	2,5÷9	14	37	BDB-324124

A Manual override

Double electric impulse 18 mm

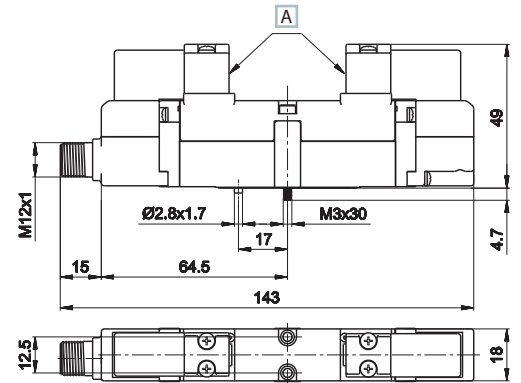

Weight (Kg): 0,136

	Symbol	Control	Return	Pressure bar	Time (ms)		Part no.
					En.	De-en.	
5/2		electric amplified	electric amplified	0,8÷9	16	16	BDB-324424
5/3 c.c.		electric amplified	electric amplified	2,1÷9	14	31	BDB-334424
5/3 o.c.		electric amplified	electric amplified	2,1÷9	14	31	BDB-344424
5/3 p.c.		electric amplified	electric amplified	2,1÷9	31	14	BDB-354424
3/2 NC + 3/2 NC		electric amplified	electric amplified	1,8÷9	17	22	BDB-364424
3/2 NC + 3/2 NO		electric amplified	electric amplified	1,8÷9	17	22	BDB-374424
3/2 NO + 3/2 NO		electric amplified	electric amplified	1,8÷9	17	22	BDB-384424

A Manual override

ELECTRIC FEATURES

- Central electric connector M12x1
- IP 65 protection degree
- 24 V DC voltage
- 2,5 W nominal power
- DD-052** series coil (without faston)
- ED 100%
- LED indicator
- Available upon request other voltages
- max 48V DC

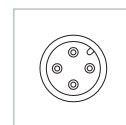
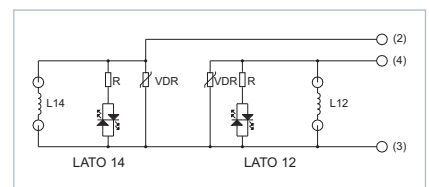

o.c. = open centres c.c. = closed centres p.c. = pressurize centres

Single electric impulse 26 mm

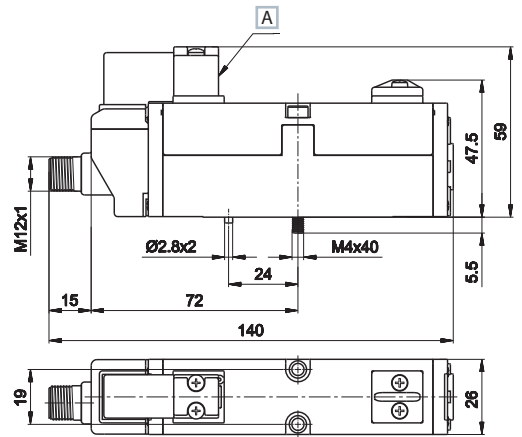

Weight (Kg): 0,205

	Symbol	Control	Return	Pressure bar	Time (ms)		Part no.
					En.	De-en.	
5/2		electric amplified	molla pneumo mechanical	1,8÷9	21	40	BDB-424024
5/2		electric amplified	molla mechanical	2,5÷9	20	50	BDB-424124

A Manual override

Double electric impulse 26 mm

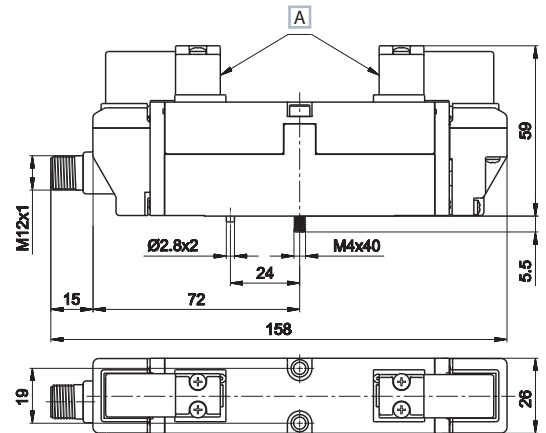

Weight (Kg): 0,236

	Symbol	Control	Return	Pressure bar	Time (ms)		Part no.
					En.	De-en.	
5/2		electric amplified	electric amplified	2,5÷9	17	17	BDB-424424
5/3 c.c.		electric amplified	electric amplified	2,1÷9	16	54	BDB-434424
5/3 o.c.		electric amplified	electric amplified	2,1÷9	16	54	BDB-444424
5/3 p.c.		electric amplified	electric amplified	2,1÷9	63	16	BDB-454424
3/2 NC + 3/2 NC		electric amplified	electric amplified	1,8÷9	20	27	BDB-464424
3/2 NC + 3/2 NO		electric amplified	electric amplified	1,8÷9	20	27	BDB-474424
3/2 NO + 3/2 NO		electric amplified	electric amplified	1,8÷9	20	27	BDB-484424

A Manual override

ELECTRIC FEATURES

- Central electric connector M12x1
- IP 65 protection degree
- 24 V DC voltage
- 2,5 W nominal power
- DD-052** series coil (without faston)
- ED 100%
- LED indicator

Available upon request other voltages
max 48V DC

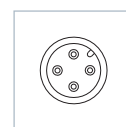
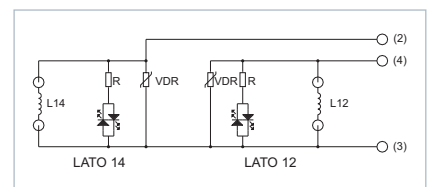

o.c. = open centres c.c. = closed centres p.c. = pressurize centres

Single electric impulse 18 mm

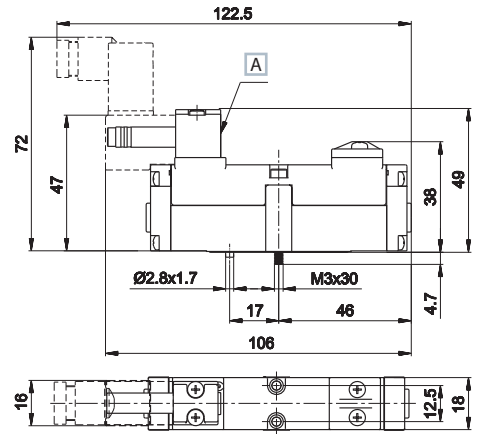

A Manual override

Weight (Kg): 0,107

	Symbol	Control	Return	Pressure bar	Time (ms)		Part no.
					En.	De-en.	
5/2		electric amplified	pneumo mechanical spring	1,8÷9	15	25	BDA-3240
5/2		electric amplified	mechanical spring	2,5÷9	14	37	BDA-3241

Double electric impulse 18 mm

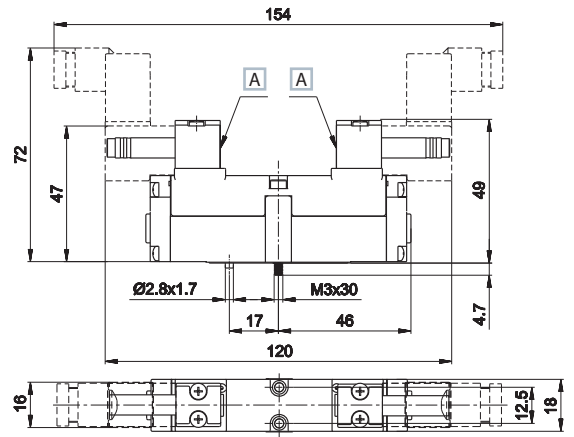

A Manual override

Weight (Kg): 0,123

	Symbol	Control	Return	Pressure bar	Time (ms)		Part no.
					En.	De-en.	
5/2		electric amplified	electric amplified	0,8÷9	16	16	BDA-3244
5/3 c.c.		electric amplified	electric amplified	2,1÷9	14	31	BDA-3344
5/3 o.c.		electric amplified	electric amplified	2,1÷9	14	31	BDA-3444
5/3 p.c.		electric amplified	electric amplified	2,1÷9	31	14	BDA-3544
3/2 NC + 3/2 NC		electric amplified	electric amplified	1,8÷9	17	22	BDA-3644
3/2 NC + 3/2 NO		electric amplified	electric amplified	1,8÷9	17	22	BDA-3744
3/2 NO + 3/2 NO		electric amplified	electric amplified	1,8÷9	17	22	BDA-3844

o.c. = open centres c.c. = closed centres p.c. = pressurized centres

BDA solenoid valves are supplied without coils and connectors

Single electric impulse 26 mm

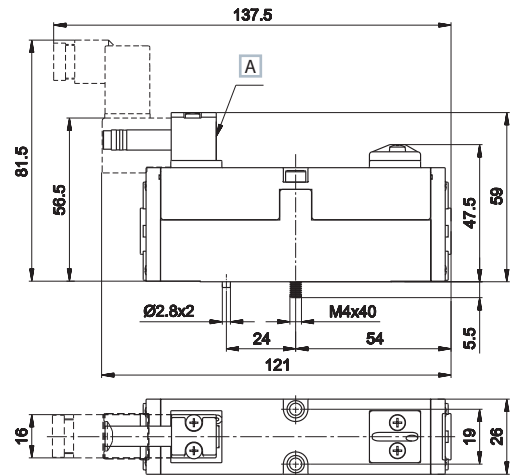

Weight (Kg): 0,197

	Symbol	Control	Return	Pressure bar	Time (ms)		Part no.
					En.	De-en.	
5/2		electric amplified	pneumo mechanical spring	1,8÷9	21	40	BDA-4240
5/2		electric amplified	mechanical spring	2,5÷9	20	50	BDA-4241

A Manual override

Double electric impulse 26 mm

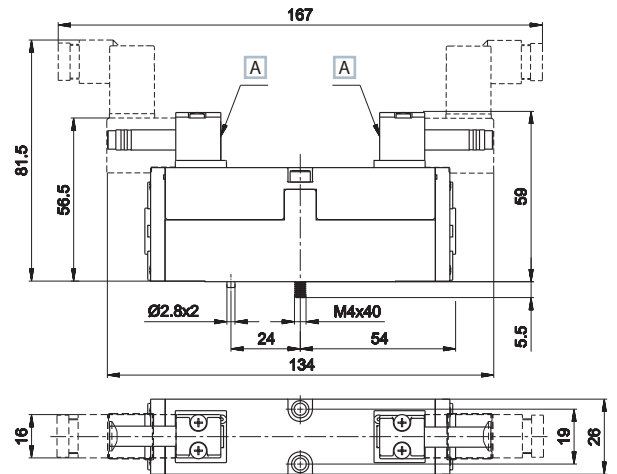

Weight (Kg): 0,218

	Symbol	Control	Return	Pressure bar	Time (ms)		Part no.
					En.	De-en.	
5/2		electric amplified	electric amplified	1,2÷9	17	17	BDA-4244
5/3 c.c.		electric amplified	electric amplified	2,1÷9	16	54	BDA-4344
5/3 o.c.		electric amplified	electric amplified	2,1÷9	16	54	BDA-4444
5/3 p.c.		electric amplified	electric amplified	2,1÷9	63	16	BDA-4544
3/2 NC + 3/2 NC		electric amplified	electric amplified	1,8÷9	20	27	BDA-4644
3/2 NC + 3/2 NO		electric amplified	electric amplified	1,8÷9	20	27	BDA-4744
3/2 NO + 3/2 NO		electric amplified	electric amplified	1,8÷9	20	27	BDA-4844

A Manual override

o.c. = open centres c.c. = closed centres p.c. = pressurized centres

BDA solenoid valves are supplied without coils and connectors

2
Standardized valves

Single/double **pneumatic impulse 18 mm**

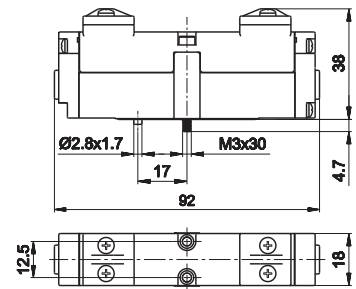

Weight (Kg): 0,092/0,098

	Symbol	Control	Return	Pressure bar	Time (ms)		Part no.
					En.	De-en.	
5/2		pneumatic amplified	pneumo mechanical spring	1,8÷10	13	30	BDA-3230
5/2		pneumatic amplified	mechanical spring	2,5÷10	11	35	BDA-3231
5/2		pneumatic amplified	pneumatic amplified	0,8÷10	8	8	BDA-3233
5/3 c.c.		pneumatic amplified	pneumatic amplified	2,1÷10	9	15	BDA-3333
5/3 o.c.		pneumatic amplified	pneumatic amplified	2,1÷10	9	15	BDA-3433
5/3 p.c.		pneumatic amplified	pneumatic amplified	2,1÷10	9	15	BDA-3533
3/2 NC + 3/2 NC		pneumatic amplified	pneumatic amplified	1,8÷10	5	14	BDA-3633
3/2 NC + 3/2 NO		pneumatic amplified	pneumatic amplified	1,8÷10	5	14	BDA-3733
3/2 NO + 3/2 NO		pneumatic amplified	pneumatic amplified	1,8÷10	5	14	BDA-3833

o.c. = open centres **c.c.** = closed centres **p.c.** = pressurized centres

Single/double pneumatic impulse 26 mm

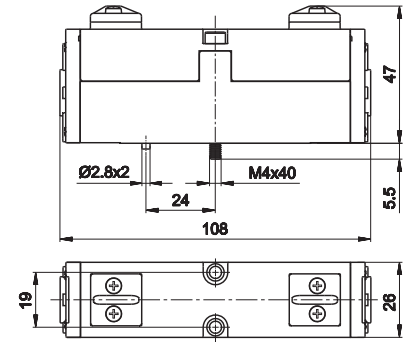

Weight (Kg): 0,185/0,204

	Symbol	Control	Return	Pressure bar	Time (ms)		Part no.
					En.	De-en.	
5/2		pneumatic amplified	pneumo mechanical spring	1,8÷10	15	33	BDA-4230
5/2		pneumatic amplified	mechanical spring	2,5÷10	13	38	BDA-4231
5/2		pneumatic amplified	pneumatic amplified	1,2÷10	10	10	BDA-4233
5/3 c.c.		pneumatic amplified	pneumatic amplified	1,2÷10	14	18	BDA-4333
5/3 o.c.		pneumatic amplified	pneumatic amplified	1,2÷10	14	18	BDA-4433
5/3 p.c.		pneumatic amplified	pneumatic amplified	1,2÷10	14	18	BDA-4533
3/2 NC + 3/2 NC		pneumatic amplified	pneumatic amplified	1,8÷10	8	14	BDA-4633
3/2 NC + 3/2 NO		pneumatic amplified	pneumatic amplified	1,8÷10	8	14	BDA-4733
3/2 NO + 3/2 NO		pneumatic amplified	pneumatic amplified	1,8÷10	8	14	BDA-4833

o.c. = open centres c.c. = closed centres p.c. = pressurized centres

Integrated electric connection side 18 mm

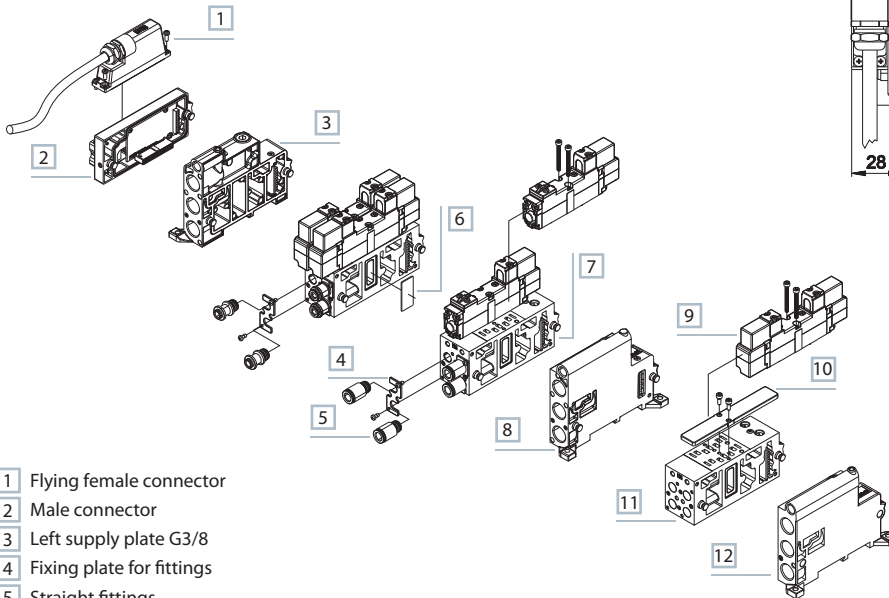
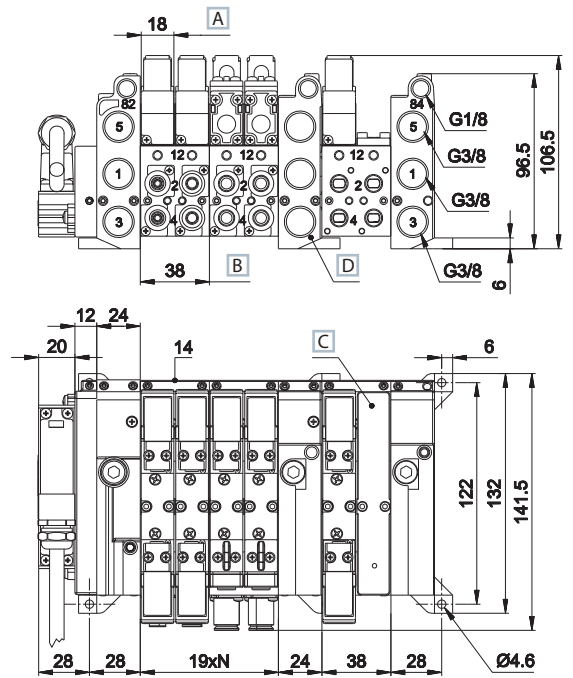
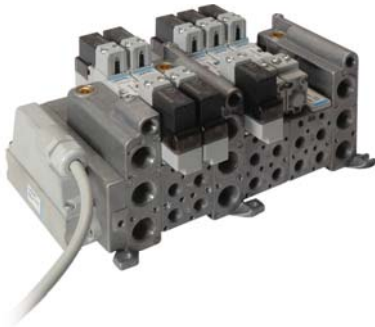

- 1 Flying female connector
- 2 Male connector
- 3 Left supply plate G3/8
- 4 Fixing plate for fittings
- 5 Straight fittings
- 6 Plate for separating pressures
- 7 Integrated electric connection
- 8 Intermediate supply plate G3/8
- 9 Solenoid valve side 18 mm
- 10 Closing plate
- 11 Sub-base 2 valve places
- 12 Right supply plate G3/8

- A Valve thickness
 - B Sub-base 2 places valve
 - C Closing plate for unused valve place BDF-3185
 - D Intermediate supply plate
- 1 = Supply port
 2 - 4 = Use
 3 - 5 = Exhaust
 14 = Control
 12 = Return
 N = Number of valve places

BDF-3100	BDF-3115	BDF-3120	BDF-3140TIM	BDF-3180	BDF-3185	BDF-3190
left supply plate G3/8 with integrated electric connection weight: 0,292 Kg	right supply plate G3/8 weight: 0,276 Kg	intermediate supply plate G3/8 with integrated electric connection weight: 0,29 Kg	multiway connection module, 25 poles male type D side 18 mm weight: 0,158 Kg	plate for separating supply pressures weight: 0,002 Kg	plate for closing unused valve place weight: 0,038 Kg	interface for connecting valves side 18-26 mm with integrated electric connection weight: 0,216 Kg

BDF-3210 (b)	BDF-3230 (a) - (b)	BDF-3310 (b)	BDF-3330 (a) - (b)	BDF-3400	GZR-100	GZR-V10004/06/08
sub base 2 places according to VDMA-ISO specifications flow rate 620 NI/min G1/8 connections weight: 0,324 Kg	sub base 2 places according to VDMA-ISO specifications flow rate 620 NI/min for fittings Ø 4-6-8 mm weight: 0,334 Kg	sub base 2 places with increased capacity 800 NI/min G1/8 connections weight: 0,322 Kg	sub base 2 places with increased capacity 800 NI/min for fittings Ø 4-6-8 mm weight: 0,334 Kg	single sub-base 1 place with increased capacity G1/8 connections weight: 0,12 Kg	screw plug weight: 0,01 Kg	fittings according to UNIVER design (package 50 pcs.) GZR-V10004 Ø4 mm GZR-V10006 Ø6 mm GZR-V10008 Ø8 mm weight: 0,01 Kg each.

(a) = sub-base including fixing plates for fittings (fittings excluded) (b) = part no. codification: 0 = electric integrated

Integrated electric connection side 26 mm

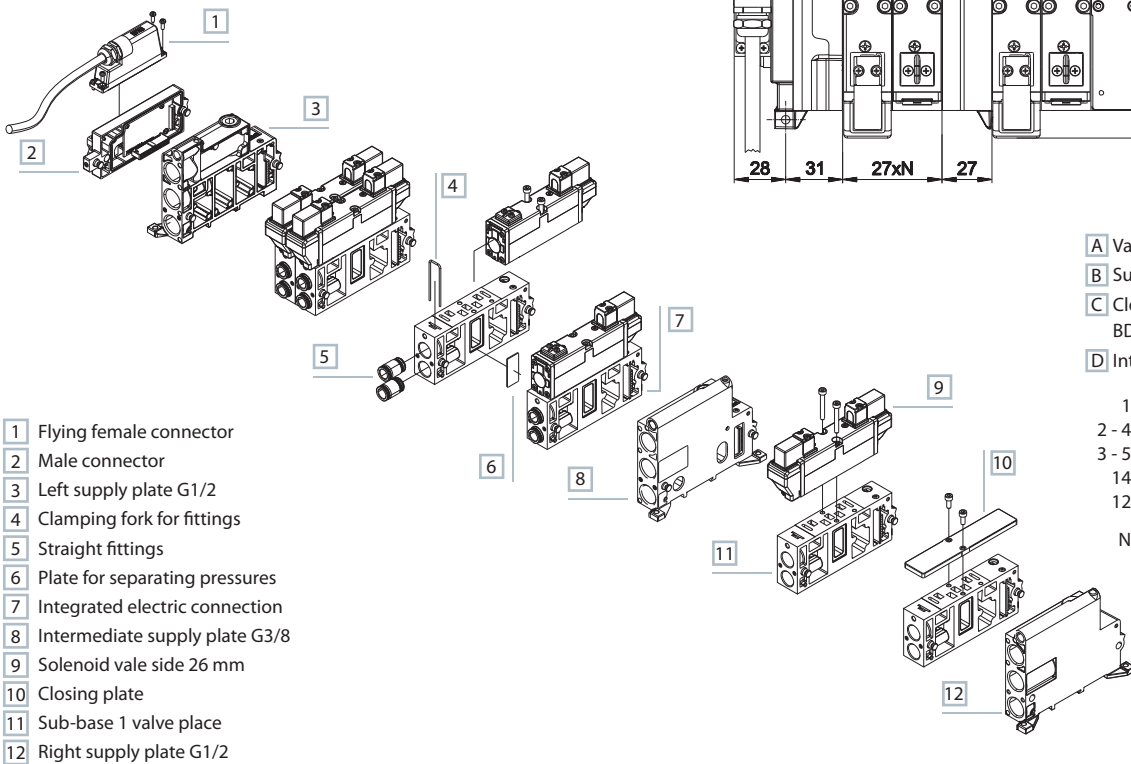
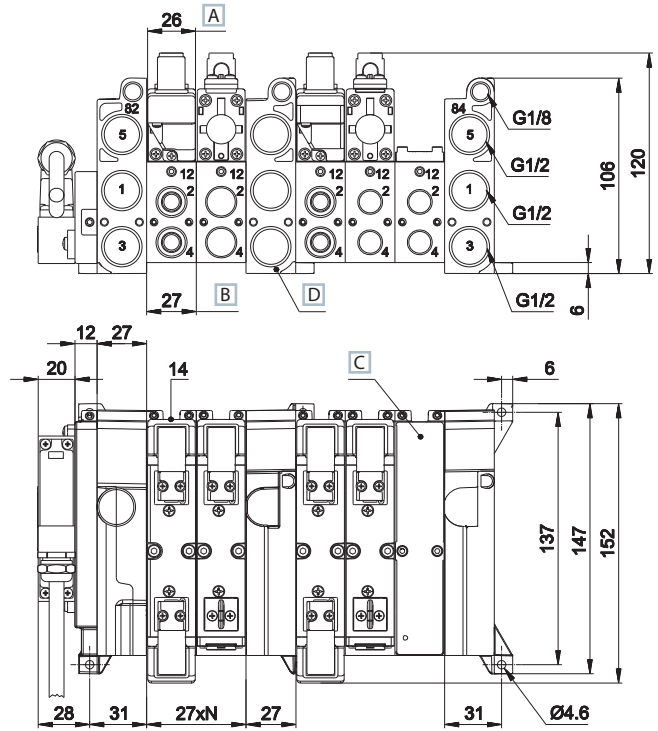

- A Valve thickness
- B Sub-base 1 place valve
- C Closing plate for unused valve place BDF-4185
- D Intermediate supply plate
- 1 = Supply port
- 2 - 4 = Use
- 3 - 5 = Exhaust
- 14 = Control
- 12 = Return
- N = Number of valve place

BDF-4100	BDF-4115	BDF-4120	BDF-4140TIM	BDF-4180	BDF-4185
left supply plate G1/2 with integrated electric connection weight: 0,396 Kg	right supply plate G1/2 weight: 0,418 Kg	intermediate supply plate G1/2 with integrated electric connection weight: 0,396 Kg	multiway connection module, 25 poles male type D side 26 mm weight: 0,158 Kg	plate for separating supply pressures weight: 0,002 Kg	plate for closing unused valve place weight: 0,08 Kg
BDF-4210/20 (b)	BDF-4230 (a) - (b)	BDF-4310/20(b)	BDF-4330/31/32(a) - (b)	BDF-4400	GZR-VV1006/08/10
sub base 1 place according to VDMA-ISO specification flow rate 1250 NI/min G1/4 connections BDF-4210 weight: 0,254 Kg G3/8 connections BDF-4220 weight: 0,246 Kg	sub base 1 place according to VDMA-ISO specification flow rate 1250 NI/min for fittings Ø 6-8-10 mm BDF-4230 weight: 0,23 Kg	sub base 1 place with increased capacity flow rate 1700 NI/min G1/4 connections BDF-4310 weight: 0,254 Kg G3/8 connections BDF-4320 weight: 0,246 Kg	sub base 1 place with increased capacity flow rate 1700 NI/min for fittings Ø 6-8-10 mm BDF-4330 weight: 0,23 Kg	single sub-base 1 place with increased capacity G3/8 connections weight: 0,226 Kg	fittings according to UNIVER design (package 50 pcs.) GZR-VV1006 Ø 6mm GZR-VV1008 Ø 8mm GZR-VV1010 Ø 10mm weight: 0,014 Kg each.

(a) = sub-base including fixing plates for fittings (fittings excluded) (b) = part no. codification: 0 = electric integrated

2
Standardized valves

Electric connection with external connector side 18 mm

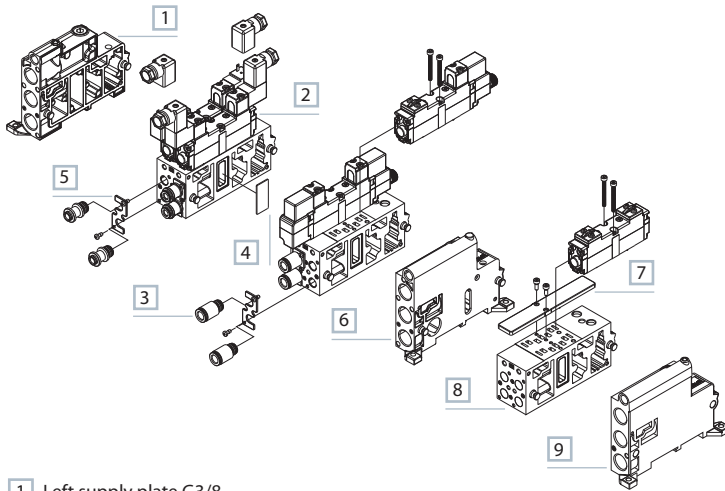

- 1 Left supply plate G3/8
- 2 Solenoid valve
- 3 Straight fittings
- 4 Plate for separating pressures
- 5 Fixing plate for fittings
- 6 Intermediate supply plate G3/8
- 7 Closing plate
- 8 Sub-base 2 valve places
- 9 Right supply plate G3/8

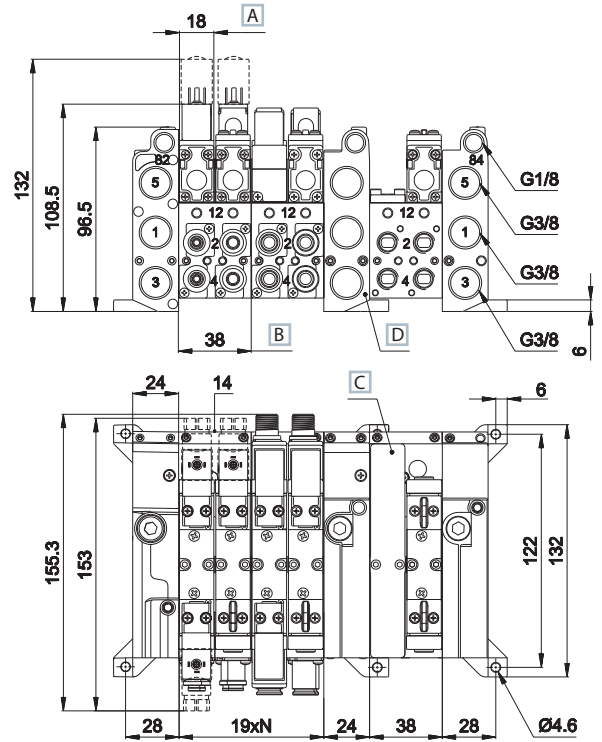

- A Valve thickness
- B Sub-base 2 places valve
- C Closing plate for unused valve place BDF-3185
- D Intermediate supply plate

- 1 = Supply port
- 2 - 4 = Use
- 3 - 5 = Exhaust
- 14 = Control
- 12 = Return
- N = Number of valve places

BDF-3110 BDF-3115 BDF-3125 BDF-3180 BDF-3185 BDF-3191 BDF-3400

left supply plate G3/8 weight: 0,288 Kg	right supply plate G3/8 weight: 0,276 Kg	intermediate supply plate G3/8 without integrated electric connection weight: 0,31 Kg	plate for separating pressures weight: 0,002 Kg	plate for closing unused valve place weight: 0,038 Kg	interface for connecting valves side 18-26 mm with integrated electric connection weight: 0,212 Kg	single sub-base 1 place with increased capacity G1/8 connections weight: 0,12 Kg

BDF-3210/1/2 (b) BDF-3230/1/2 (a) - (b) BDF-3310/1/2 (b) BDF-3330/1/2 (a) - (b) GZR-100 GZR-V10004/6/8 DD-051/..

sub base 2 places according to VDMA-ISO specifications flow rate 620 NI/min G1/8 connections BDF-3210 BDF-3211 BDF-3212 weight: 0,316 Kg	sub base 2 places according to VDMA-ISO specifications flow rate 620 NI/min for fittings Ø 4-6-8 mm BDF-3230 BDF-3231 BDF-3232 weight: 0,326 Kg	sub base 2 places with increased capacity 800 NI/min attacchi G1/8 BDF-3310 BDF-3311 BDF-3312 weight: 0,316 Kg	sub base 2 places with increased capacity flow rate 800 NI/min for fittings Ø 4-6-8 mm BDF-3330 BDF-3331 BDF-3332 weight: 0,326 Kg	screw plug weight: 0,01 Kg	fittings according to UNIVER design (package 50 pcs.) GZR-V10004 Ø4 mm GZR-V10006 Ø6 mm GZR-V10008 Ø8 mm weight: 0,01 Kg cad.	U05 coil side 15 mm (for technical features refer to section "Accessories->Coils") weight: 0,019 Kg

(a) = sub-base including fixing plates for fittings (fittings excluded)
(b) = part no. codification: 0 = electric integrated

1 = electric non integrated

2 = only pneumatic

Electric connection

AM-5109

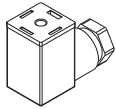

■ 15 mm connector

TSCFN24S000

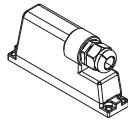

■ female connector
25 poles type D-sub
no cable
M3 x 8 fixing screws

TSCFN24S0300
TSCFN24S0500
TSCFN24S1000

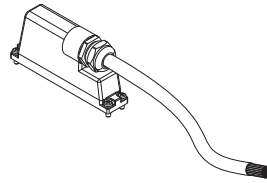

■ female connector
25 poles type D-sub
cable 3-5-10 m
M3 x 8 fixing screws

TSCFN16D0300
TSCFN16D0500
TSCFN16D1000

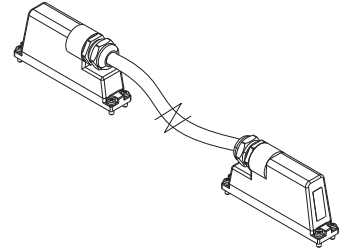

■ male/female flying connector
sub D (upon request)
prewired for 24 coils with
cable Ø 8 mm (3-5-10 m length)
suitable for mobile laying
M3 x 8 fixing screws

BDF-3140 TIM

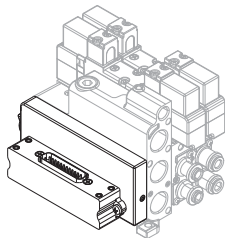

■ multiway connection module
25 poles male type D
side 18 mm

BDF-4140 TIM

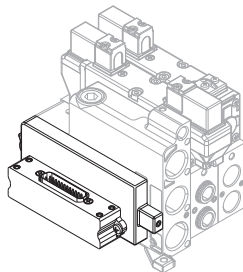

■ multiway connection module
25 poles male type D
side 26 mm

>>Colour identification according to standard DIN 47100

Female connector D-SUB 25 poles
for connection 12+12 coils

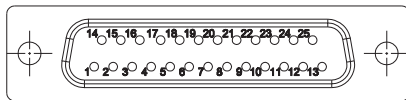

PIN No.	Control side	Valve N°	Colour	Coil
1	14	1	white	1
2	12	1	brown	2
3	14	2	green	3
4	12	2	yellow	4
5	14	3	grey	5
6	12	3	pink	6
7	14	4	blue	7
8	12	4	red	8
9	14	5	black	9
10	12	5	violet	10
11	14	6	grey-pink	11
12	12	6	red-blue	12
13	14	7	white-green	13
14	12	7	green-brown	14
15	14	8	white-yellow	15
16	12	8	yellow-brown	16
17	14	9	white-grey	17
18	12	9	grey-brown	18
19	14	10	white-pink	19
20	12	10	pink-brown	20
21	14	11	white-blue	21
22	12	11	brown-blue	22
23	14	12	white-red	23
24	-	-	brown-red brown-black shield	common low
25	12	12	white-black	24